

INSTALLATION AND USAGE HANDBOOK

TEMPORARY
ANCHOR



TEMPORARY ANCHOR
PRODUCT CODE: AP145C / AP145S

Recommended for single person use
FALL ARREST USE - 15kN RATED

READ ENTIRE HANDBOOK BEFORE
INSTALLING OR USING THIS DEVICE.

FAILURE TO FOLLOW ALL WARNINGS, INSTALLATION AND USAGE
INSTRUCTIONS MAY RESULT IN SERIOUS INJURY OR DEATH.

www.sayfa.com.au/products/anchors



READ ENTIRE HANDBOOK BEFORE INSTALLING OR USING THIS DEVICE.

FAILURE TO FOLLOW ALL WARNINGS, INSTALLATION AND USAGE INSTRUCTIONS, MAY RESULT IN SERIOUS INJURY OR DEATH.

IMPORTANT!

- / All Sayfa* products and systems must only be installed by competent persons.
- / Installers must be adequately trained and experienced in working at heights.
- / Applicable Australian Standards and OH&S Acts and Regulations, Codes of Practice and Guidelines must be strictly adhered to.
- / Sayfa Group instructions and recommendations, drawings and diagrams and all other documentation are copyright, errors and omissions excepted, and must be carefully read and implemented.
- / Failure to follow site installation requirements and warnings, may result in serious injury or death.
- / Sayfa Group accepts no direct or indirect responsibility and/or consequential liability whatever, for any products and systems incorrectly installed or certified.
- / Sayfa Group cannot warrant the integrity or suitability of the structure to which the products may be attached.
- / Structural integrity or suitability must be assessed by a qualified design engineer, unless authorised or approved by a competent person.
- / Any assistance or guidance given is without prejudice, and Sayfa Group cannot be held responsible for any inaccuracy or misinterpretation whatever.

SPYDA TEMPORARY ANCHOR KIT

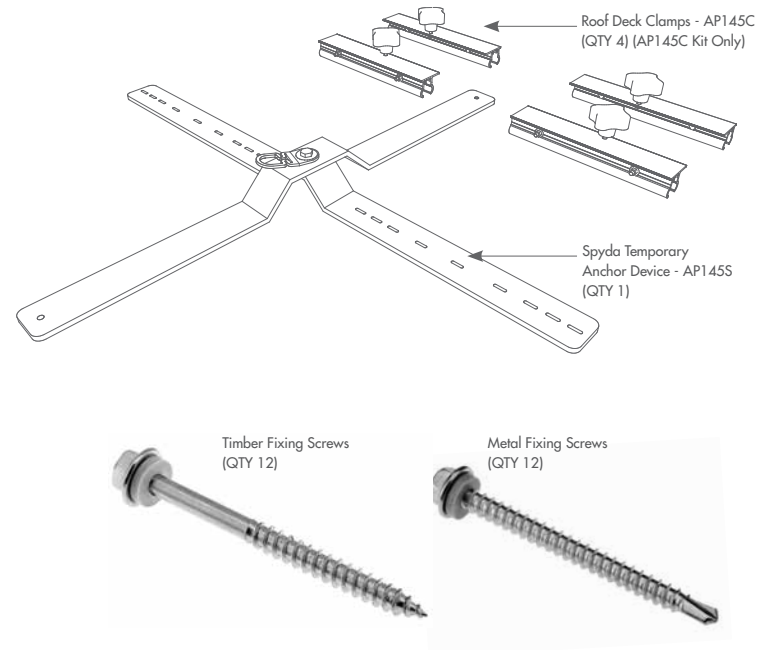

TEMPORARY
ANCHOR
15kN Rated



CONTENTS

- 4 / GENERAL INSTRUCTIONS
- 6 / ASSEMBLING THE SPYDA TEMPORARY ANCHOR
- 8 / INSTALLING THE SPYDA TEMPORARY ANCHOR
- 12 / POSITIONING THE SPYDA TEMPORARY ANCHOR
- 14 / REMOVING THE SPYDA TEMPORARY ANCHOR
- 14 / CARE AND MAINTENANCE OF THE SPYDA TEMPORARY ANCHOR
- 15 / LIMITS OF USE FOR THE SPYDA TEMPORARY ANCHOR
- 16 / IN THE EVENT OF A FALL
- 16 / WARRANTY OF THE SPYDA TEMPORARY ANCHOR
- 18 / INSPECTION CRITERIA FOR THE SPYDA TEMPORARY ANCHOR

READ ALL INSTRUCTIONS CAREFULLY - YOUR LIFE MAY DEPEND ON IT.

- / This device is recommended for single person use, unless being used for rescue - 15kN rated.
- / Only competent persons trained in the safe use of fall arrest systems to check, install or use this device.
- / Visual inspection of all Spyda Temporary Anchor componentry and fixings to be done prior to use.
- / This device has a 10 year usage life span after which it must be removed from service. (As per AS/NZS 1891.4:2009 and AS/NZS 5532:2013.)
- / Failure to follow all warnings, installation and usage instructions may result in serious injury or death.



The Spyda Temporary Anchor Point has been tested in accordance with Australian Standards AS/NZS 1891.4:2009 and AS/NZS 5532:2013 and is rated at 15 kN.

GENERAL INSTRUCTIONS

- / All assembly and installation instructions must be read and understood prior to installing and/or using this device.
- / Visually inspect all componentry and fixings for any signs of damage, deterioration or distortion. (See checklist page 17).
- / Ensure all associated risks are identified and controlled before proceeding with installation. Complete all necessary documentation, including a JSA (Job Safety Analysis) with an authorised Work Method Statement.
- / Authorisation to enter any risk area must be obtained from the person in control of the workplace prior to accessing.
- / Visually inspect structure to which this device will be attached.

COMPATIBLE ROOF DECK PROFILES FOR SPYDA "SCREW FIX" INSTALLATION



- / Ensure support structure can sustain required loads. (Approval may be required from a qualified engineer).
- / This device is designed to absorb a fall load by deforming the swivel eye attachment point limiting the resultant load on structure to approximately 8kN.
- / Ensure this device is fixed to 'compatible' roof deck profiles only
- / Ensure this device is set up to prevent access beyond a fall edge, controlled by correct lanyard length.
- / This device must be used in conjunction with an Australian Standards approved full body harness and energy absorbing lanyard.

- / Correct positioning of this device is essential so there is no possible 'pendulum fall' of the operator.
- / Usage and maintenance of this device must be as per all relevant Australian Standards, Codes of Practice, OH&S Acts, regulatory requirements and manufacturer's guidelines.

COMPATIBLE ROOF DECK PROFILES FOR SPYDA "CLAMP ON" INSTALLATION



NON COMPATIBLE ROOF DECK PROFILES FOR SPYDA "CLAMP ON" INSTALLATION



ASSEMBLING THE SPYDA TEMPORARY ANCHOR

- / Remove the Spyda Temporary Anchor device from the carry bag.
- / Remove deck clamps from inner bags - if 'clamp on' installation required. (AP145C option only.)
- / Open arms into open cross configuration - approximately 90° to each other.

OPTION 1 /

IF FIXING TO 'SCREW FIX' TYPE ROOF - DIAG 1

- / No attachment of deck clamps required.
- / The Spyda Anchor is now ready to install on roof, as required.
- / Screws (6) - for fixing to metal structure
- / Screws (6) - for fixing to timber structure

See Page 8 for Installation Instructions

DWG 1 - Screw fix option (no clamps required)

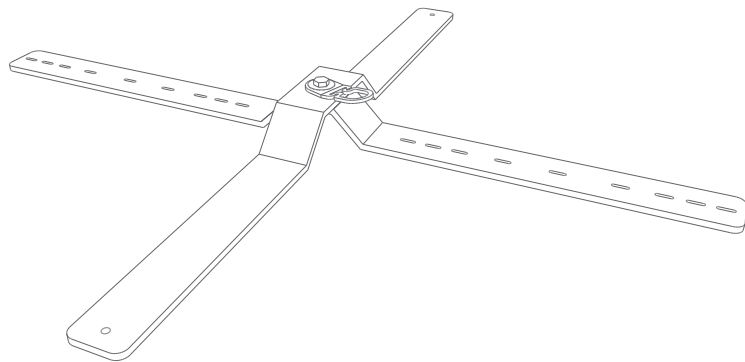

DWG 2 - Clamp fix option

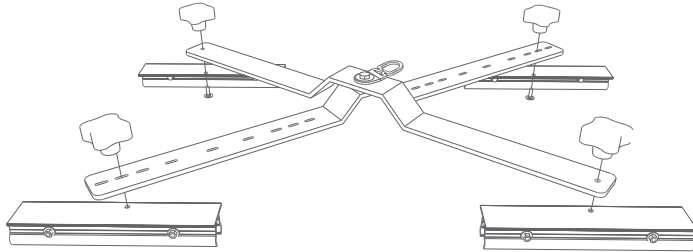

OPTION 2 / IF FIXING TO 'CLIP FIX' TYPE ROOF - DWG 2

- / Assemble Part A and Part B of (4) deck clamps.
- / Insert long bolts (Bolt #1) through Part A and Part B, loosely tighten the nuts.
- / Insert short bolt (Bolt #2) through deck clamps and holes on 'support arms'. Loosely tighten thumbscrews. Repeat steps for (4) deck clamps
- / Attach (4) deck clamps to 'support arms'
- / The Spyda Anchor is now ready to install on roof, as required.

See Page 10 for Installation Instructions

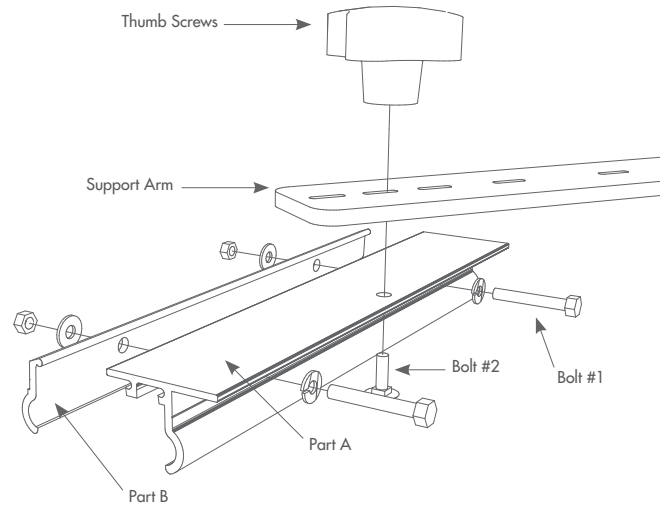

INSTALLING THE SPYDA TEMPORARY ANCHOR

OPTION 1 / IF FIXING TO 'SCREW FIX' TYPE ROOF

- / Ensure all risks are identified and controlled before installing or using this device.
- / Open support arms into open cross configuration, approx 90° to each other (Diag 3).
- / Remove existing roof deck fixing screws. Check integrity of battens - if unsure, consult engineer.
- / Position 'slotted arm' at right angles to direction of roof deck and position 'secondary arm' on roof deck ribs (DWG 3). **Do not fix this arm.**
- / Fix 'slotted arm' to roof deck/support structure with (6) 14g x 75mm Tek screws.
- Metal fixing** - Screws must penetrate structure by at least 75mm (DWG 4)
- Timber fixing** - Screws must penetrate structure by at least 40mm (DWG 5)
- / Check Spyda Temporary Anchor is fixed securely. Attach energy absorbing lanyard to swivel eye.

 Before installing or using this device - be sure to read and understand all instructions and warnings.

Work in a safe manner at all times.

DWG 3 - Screw fix option

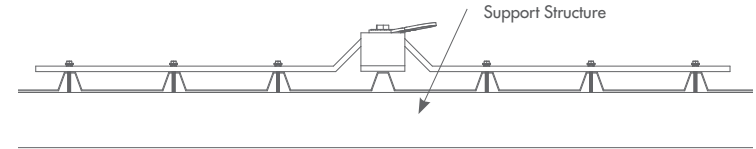
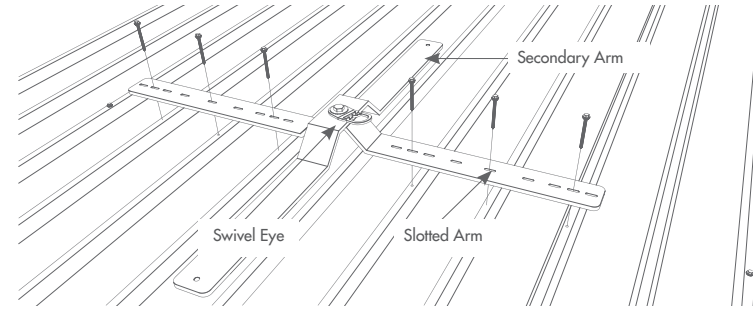

DWG 4 - Metal fixing

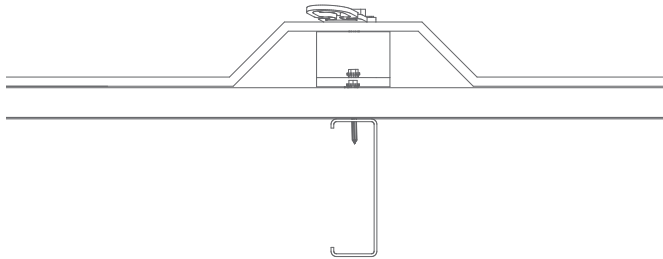

- ⚠ Minimum 20mm penetration into metal purlin, using appropriate screws for metal fixing.
- Minimum purlin size - 150 x 1.9mm
- Minimum 3 purlins required

DWG 5 - Timber fixing

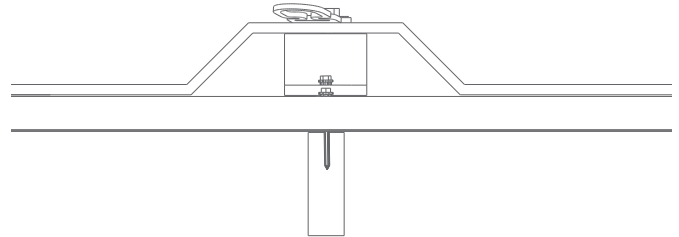

- ⚠ Minimum 40mm penetration into timber purlin/batten using appropriate screws for timber fixing.
- Minimum timber size 70 x 35 MPG10 (F7)
- Minimum 3 purlins required

INSTALLING THE SPYDA TEMPORARY ANCHOR

OPTION 2/ IF FIXING TO 'CLIP FIX' TYPE ROOF

- / Ensure all risks are identified and controlled before installing or using this device.
- / Open support arms into open cross configuration, approx 90° to each other.
- / Position arms diagonally to direction of roof deck (DWG 6).
- / Loosen deck clamp bolts and locate clamps over roof deck ribs (DWG 7).
- / Any (2) of the deck clamps must be located directly above the purlin (DWG 6). Do not position deck clamps on a roof sheet lap joint (DWG 8).
- / Tighten (8) M8 deck clamp bolts to minimum torque of 28NM. (Approx 3 revolutions, once finger tight).
- / Tighten thumbscrews securely (hand tight is sufficient).
- / Check Spyda Temporary Anchor is fixed securely.
Attach energy absorbing lanyard to swivel eye.

 Before installing or using this device - be sure to read and understand all instructions and warnings.

Work in a safe manner at all times.

DWG 6 - Clamp fix option

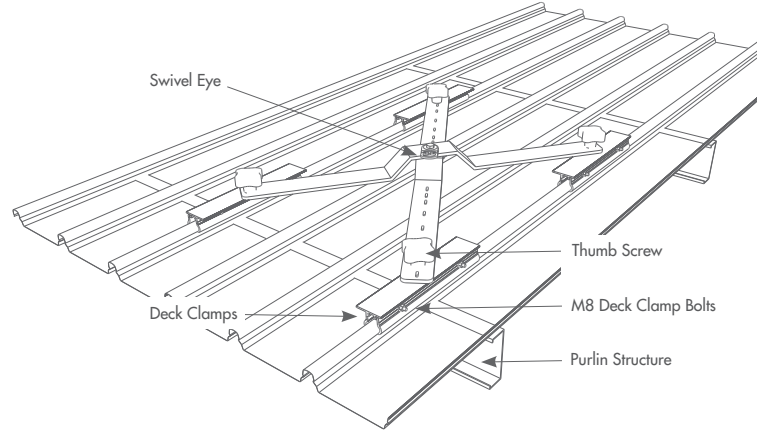

DWG 7 - Correct clamp placement
(Off roof sheet lap joint)

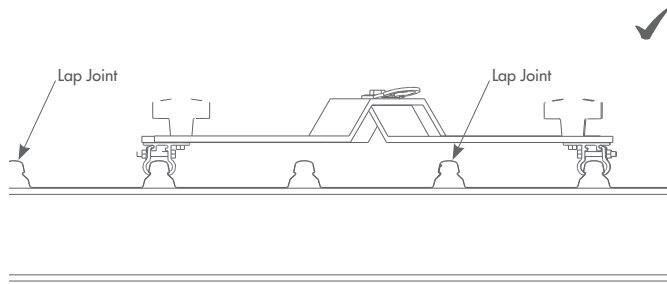

DWG 8 - Incorrect Clamp Placement
(Off roof sheet lap joint)

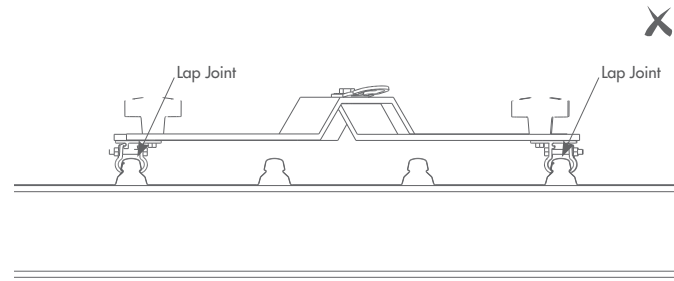

Clamps to be located over purlin.
Do not place clamp on roof sheet lap joint.

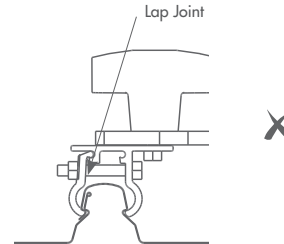

POSITIONING OF THE SPYDA TEMPORARY ANCHOR

- / Ensure this device is not located in proximity of any risk/hazardous areas ie. brittle roofs, radioactive areas, immediate fall hazard areas etc.
- / Always set up this device in the safe zone of the roof where no fall is possible.
Only approach fall zone once operator is safely connected to the anchor via harness and energy absorbing lanyard.
- / Before use of the anchor a rescue plan must be in place in case of a fall, see page 16.

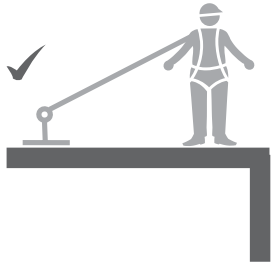

- / Ensure this device is set up to prevent access beyond a fall edge.
- / Lanyard/ropeline slack must be kept to a minimum.
- / Ensure supporting structure can sustain all required loadings in the event of a fall.
(Approval from a qualified engineer may be required).

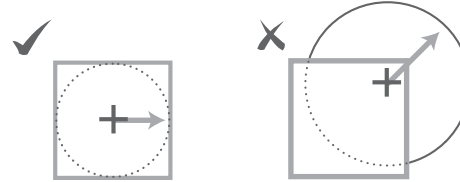
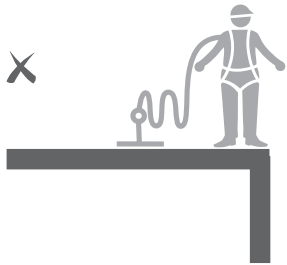

- / Ensure this device is correctly located.
- / Operator must be protected from possible 'pendulum fall'.

Pendulum Fall

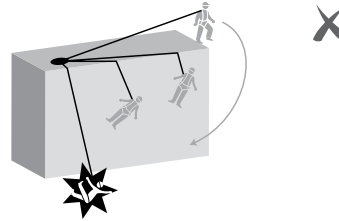

Always work using the restraint technique, ensure there is no possibility of a 'pendulum fall'!

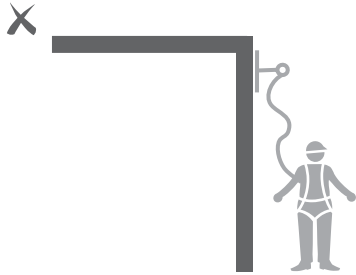

/ Do not install or use this device in a vertical application.

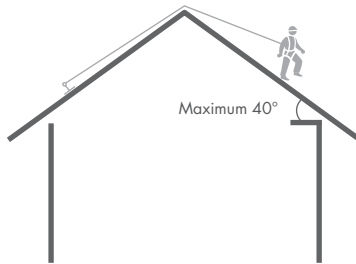

/ Do not locate this device on a roof/slope exceeding 40°.

/ Ensure this device is located on opposite pitch and used in restraint only, when working on pitched roofs.

- / When using a temporary webbing static line, end anchors must be screw fixed and positioned to ensure the operator is protected from possible 'pendulum fall'.
- / Temporary webbing static lines connected to Spyda Temporary Anchors must have a maximum span of 10.0M. One user per span.
- / Temporary webbing static lines connected to Spyda Temporary Anchors can only have a maximum end load of 15kN.

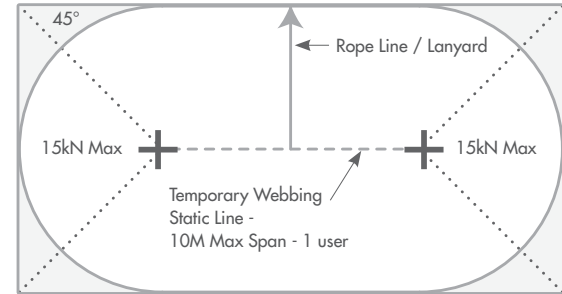

 This device may only be used in conjunction with a proprietary temporary webbing static line, provided the end anchor loading does not exceed 15kN. Maximum single span is 10.0M. Span can be increased by adding additional Spyda Temporary Anchors (screw fix only) as intermediate anchors. Maximum one user per span. Clamp fix option is not to be used for static line loading.

REMOVING THE SPYDA TEMPORARY ANCHOR SCREW FIX REMOVAL

- / Remove all structure fixing screws from the support arms.
- / Remove and fold away the Spyda Anchor. Place in carry bag. Ensure all components and fixings are stored safely.
- / Replace all fixing screws to roof. Ensure good fixing and seal integrity of roof is maintained.

CLAMP FIX REMOVAL

- / Loosen thumbscrews. Remove the Spyda Anchor from deck clamps.
- / Remove and fold away the Spyda Anchor. Place in carry bag.
- / Loosen deck clamp bolts and remove clamps from roof deck.
- / Store deck clamps in small bags and place in carry bag.
- / Check all roof sheets are left secured and seal integrity is maintained.



Ensure you remain safe during and after removal of this device.

CARE AND MAINTENANCE OF THE SPYDA TEMPORARY ANCHOR

- / Ensure this device has been inspected, assessed and certified by a competent person within the last 6 months. (A record must be noted on the inspection card provided, see pages 18 and 19).
- / Visual inspection of all componentry and fixings to be done prior to use by the operator. Should any faults and/or damage be apparent - device must not be used until inspected, assessed and certified in accordance with AS/NZS 1891.4:2009 and AS/NZS 5532:2013.
- / This device must be removed from service if it has arrested a fall or sustained any abnormal loading.
- / The Spyda Temporary Anchor has a 10 year usage lifespan, once this period has expired or this device has been damaged in any way - this device must be tagged clearly 'out of service' and removed from service or destroyed.
- / All fixing screws (red and yellow) must be replaced at least every fifth time of use/installation or sooner if visual deterioration is noted.
 - Metal Fixing Screws** - Self Drilling 14g x 75mm Tek screws
 - Timber Fixing Screws** - Type 17 14g x 75mm Tek screws.

- / Under no circumstances must any modifications or repairs be done to this device unless authorised by the manufacturer.
- / Take care to protect this device from excessive impact, heat or corrosive substances, which may affect performance of the unit.
- / Store device in carry bag at all times.



All ancillary equipment ie. harness gear and equipment must be inspected in accordance with applicable regulatory requirements.

LIMITS OF USE FOR THE SPYDA TEMPORARY ANCHOR

- / The Spyda Temporary Anchor is recommended for single person use, unless being used for rescue - 15kN rated.
- / This device must not be installed on roof/slope greater than 40°.
- / Do not use the Spyda Temporary Anchor with non compatible roof decks (see compatible roof decks on Page 5).
- / If this device is used as a 'rescue' anchorage, it must be screw fixed only – (see screw fix fitment Page 8).
- / This device must not be installed or used as a permanent or abseil anchor.
- / If this device is to be used in corrosive or extreme environments, approval from competent or authorised personnel must be sought.
- / Do not use device if excessive structural or roof deterioration has occurred.
- / When using this device with a temporary webbing static line, loading on the end Spyda Anchors must not exceed 15kN.
- / Only use the Spyda Temporary Anchor in conjunction with an Australian Standards approved full body harness with energy absorbing lanyard.

IN THE EVENT OF A FALL

- / Do not work at height alone, ensure a minimum of (2) persons when working above 2 metres.
- / Ensure a rescue plan is in place, and all parties are aware of work in progress.
- / In the event of a fall, particularly if the person is suspended or body movement or breathing is restricted leading to loss of consciousness - seek urgent medical attention - **Serious injury or death can occur within minutes.**
- / In accordance with your rescue plan and/or appropriate first aid procedures - remove the person from the suspended position as quickly as possible, seek medical attention for fall trauma/shock.
- / Any componentry or equipment which has arrested a fall or sustained abnormal loadings must be removed from service immediately.
- / Affix a label with date and condition/or reason of defect - label to state: 'Do not use, device has been subjected to abnormal loadings'.
- / Componentry or equipment to be inspected, assessed and certified by a competent person, who must authorise a repair or device must be destroyed.

WARRANTY

1 year from date of purchase subject to correct installation, use and maintenance in accordance with manufacturer's specifications and recommendations.

The Spyda Temporary Anchor has a 10 year usage lifespan, once this period has expired or this device has been damaged in any way - this device must be tagged clearly 'out of service' and removed from service or destroyed.



The following points must be checked prior to use. Should any faults and/or damage be apparent - device must not be used until inspected, assessed and certified by a competent person in accordance with AS/NZS 1891.4:2009 and AS/NZS 5532:2013.

| | |
|--|--|
| | Check for visual signs of damage, deterioration or distortion of: \ Support Arms \ Swivel Eye Attachment Point \ Thumbscrews \ High Tensile Bolts \ Fixing Screws |
| | Ensure all bolts and fixings are securely tightened. |
| | Ensure device has not been subjected to abnormal/excessive loads. |
| | Ensure device has been inspected, assessed and certified within the last 6 months. |
| | Ensure this device is set up and used to prevent access beyond a fall edge. |
| | This device must be used in conjunction with an Australian Standards approved full body harness with energy absorbing lanyard |

6 MONTHLY PERIODIC INSPECTION OF THE SPYDA TEMPORARY ANCHOR

As per basic inspection criteria - this is to be done by a competent person. Report must be noted on the assessment/inspection record.

INSPECTION CRITERIA



This temporary anchor point must be inspected, assessed and certified in accordance with AS/NZS 1891.4:2009 and AS/NZS 5532:2013.

A record must be noted on this assessment/inspection record. Only competent persons trained in the safe use of fall arrest systems to check, install or use this device.

ASSESSMENT/ INSPECTION RECORD

| DATE | INSPECTED BY | DATE | INSPECTED BY |
|------|--------------|------|--------------|
| | | | |
| | | | |
| | | | |
| | | | |
| | | | |
| | | | |
| | | | |
| | | | |
| | | | |

INSTALLATION AND USAGE HANDBOOK

TEMPORARY
ANCHOR



If unsure, call Spyda technical department.

Sayfa Group
T\ 1300 301 755
F\ 1300 881 092
W\ www.sayfa.com.au
E\ technical@sayfa.com.au

www.sayfa.com.au/products/anchors

SAYFAGROUP-30.5.2018